



MARIANtech®
ARCHITECTURAL SOLUTIONS

controsoffitti
ceilings



INDEX

CEILINGS

CONTROSOFFITTI / FAUX-PLAFONDS / TECHOS / ZWISCHENDECKE

CE MESH TYPES

MAGLIA / MAILLES / MALLAS / MASCHES

- RHOMBOIDAL
ROMBOIDALE / RHOMBOÏDALES / ROMBOIDAL / RHOMBISCH
- ROUND
TONDA / RONDES / REDONDA / RUND
- SQUARE
QUADRA / CARRÉES / CUADRADA / QUADRATISCH
- HEXAGONAL
ESAGONALE / HEXAGONALES / HEXAGONAL / SECHSECKIG

CEILING TILES

PANNELI CONTROSOFFITTI / DALLES PLAFOND / CANTOS / DECKENPLATTEN

LAY-IN - SP

- IN APPOGGIO / SUSPENDU-T / APOYADOS / AUFGELEGT

LAY-IN BENT - FL

- A FILO / AFFLEURÉ / ENRASADOS / BÜNDIG

LAY-OUT - TG

- RIBASSATI / TÉGULAIRE / TEGULARES / MIT GEFALZTEN KANTEN

PANELS BENT ON SHORT SIDE - FSP

- PANNELI PIEGATI SU LATO CORTO / DALLES AVEC LARGEURS PLIÉES / CANTOS CORTOS PLEGADOS / AUF DER BREITE GEFALTETE PANEELE

PANELS BENT ON LONG SIDE - FLP

- PANNELI PIEGATI SU LATO LUNGO / DALLES AVEC LONGUEURS PLIÉES / CANTOS LARGOS PLEGADOS / AUF DER LÄNGE GEFALTETE PANEELE

REMOVABLE CEILING PANELS WITH HIDDEN SYSTEM - HP

- PANNELI RIMOVIBILI CON STRUTTURA NASCOSTA/ DALLES AMOVIBLES AVEC SYSTÈMES CACHÉS / OCULTOS DESMONTABLES / ABNEHMBARE DECKENPLATTEN

MATERIALS AND FINISHES

MATERIALI E FINITURE / MATÉRIAUX ET FINITIONS / MATERIALES Y ACABADOS / MATERIALIEN UND OBERFLÄCHEN

PROJECTS

REFERENZE / TRAVAUX DE RÉFÉRENCE / REFERENCIA OBRAS / REFERENZEN



CEILINGS

CONTROSOFFITTI
FAUX-PLAFONDS
TECHOS
ZWISCHENDECKE

MESH TYPES

RHOMBOIDAL

ROMBOIDALE / RHOMBOÏDALES / ROMBOIDAL / RHOMBISCH

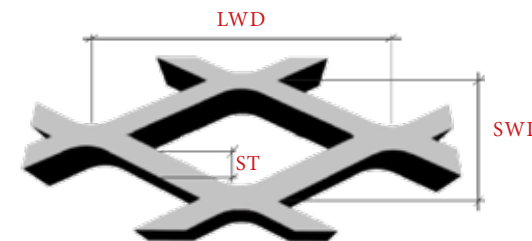
**MODEL EQ10**

	LWD	SWD	ST
Expanded metal / Lamiera stirata / Métal déployé / Expandido / Streckgitter	10	6	1,2
Open area / Vuoto su pieno / Transparence / Transparencia / Durchlass	58		(%)
Weight / Peso / Poids / Peso / Gewicht	3,14		(Kg/m ²)
Thickness / Spessore / Épaisseur / Espesor / Stärke	1		(mm)

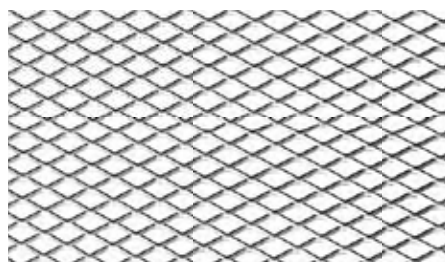
**MODEL EQ15**

	LWD	SWD	ST
Expanded metal / Lamiera stirata / Métal déployé / Expandido / Streckgitter	16	8	1,5
Open area / Vuoto su pieno / Transparence / Transparencia / Durchlass	62		(%)
Weight / Peso / Poids / Peso / Gewicht	2,99		(Kg/m ²)
Thickness / Spessore / Épaisseur / Espesor / Stärke	1		(mm)

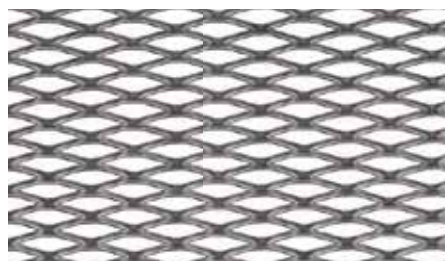
**MODEL EQ28**

	LWD	SWD	ST
Expanded metal / Lamiera stirata / Métal déployé / Expandido / Streckgitter	28	13	2
Open area / Vuoto su pieno / Transparence / Transparencia / Durchlass	69		(%)
Weight / Peso / Poids / Peso / Gewicht	3,62		(Kg/m ²)
Thickness / Spessore / Épaisseur / Espesor / Stärke	1,5		(mm)

***NOTE:** LIST OF MOST COMMON MESHES. ASK FOR OTHER MODELS OR THICKNESSES
 LISTA DELLE MAGLIE PIÙ COMUNI. ALTRI MODELLI O SPESSORI SU RICHIESTA
 LISTE DES MAILLES LES PLUS COMMUNES. DEMANDEZ D'AUTRES MODÈLES OU ÉPAISSEURS
 LISTADO DE MALLAS MÁS HABITUALES. OTROS MODELOS O ESPEORES CONSULTAR
 LISTE DER HÄUFIGSTEN STRECKGITTER. FRAGEN SIE NACH ANDEREN MODELLEN ODER STÄRKEN

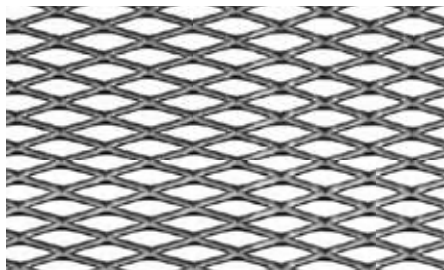
**MODEL EQ29**

LWD SWD ST

Expanded metal / Lamiera stirata / Métal déployé / Expandido / Streckgitter	29 x 9 - 2,5	(mm)
Open area / Vuoto su pieno / Transparence / Transparencia / Durchlass	45	(%)
Weight / Peso / Poids / Peso / Gewicht	6,55	(Kg/m ²)
Thickness / Spessore / Épaisseur / Espesor / Stärke	1,5	(mm)

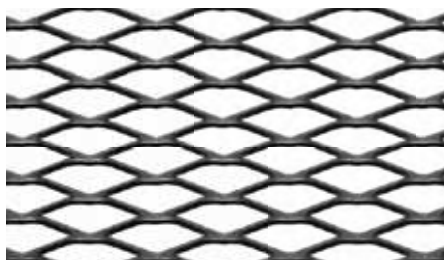
**MODEL EQ43**

LWD SWD ST

Expanded metal / Lamiera stirata / Métal déployé / Expandido / Streckgitter	43 x 13 - 2,5	(mm)
Open area / Vuoto su pieno / Transparence / Transparencia / Durchlass	62	(%)
Weight / Peso / Poids / Peso / Gewicht	4,53	(Kg/m ²)
Thickness / Spessore / Épaisseur / Espesor / Stärke	1,5	(mm)

**MODEL EQ50**

LWD SWD ST

Expanded metal / Lamiera stirata / Métal déployé / Expandido / Streckgitter	50 x 24 - 4	(mm)
Open area / Vuoto su pieno / Transparence / Transparencia / Durchlass	67	(%)
Weight / Peso / Poids / Peso / Gewicht	3,93	(Kg/m ²)
Thickness / Spessore / Épaisseur / Espesor / Stärke	1,5	(mm)

***NOTE:** LIST OF MOST COMMON MESHES. ASK FOR OTHER MODELS OR THICKNESSES
 LISTA DELLE MAGLIE PIÙ COMUNI. ALTRI MODELLI O SPESSORI SU RICHIESTA
 LISTE DES MAILLES LES PLUS COMMUNES. DEMANDEZ D'AUTRES MODÈLES OU ÉPAISSEURS
 LISTADO DE MALLAS MÁS HABITUALES. OTROS MODELOS O ESPEORES CONSULTAR
 LISTE DER HÄUFIGSTEN STRECKGITTER. FRAGEN SIE NACH ANDEREN MODELLEN ODER STÄRKEN

MESH TYPES

ROUND

TONDA / RONDAS / REDONDA / RUND

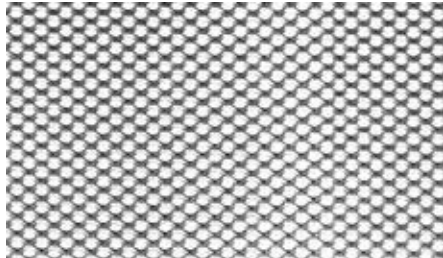
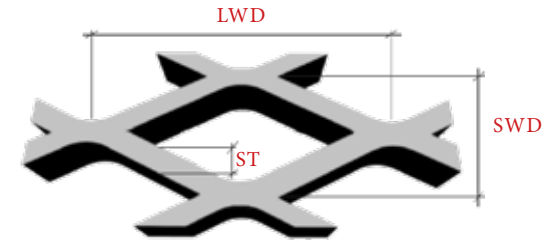

MODEL EQ - RD - 8 - Ø3

	LWD	SWD	ST
Expanded metal / Lamiera stirata / Métal déployé / Expandido / Streckgitter	8 x 5,8 - 1,5		(mm)
Open area / Vuoto su pieno / Transparence / Transparencia / Durchlass	48		(%)
Weight / Peso / Poids / Peso / Gewicht	4,07		(Kg/m ²)
Thickness / Spessore / Épaisseur / Espesor / Stärke	1		(mm)



MODEL EQ - RD - 10 - Ø5

	LWD	SWD	ST
Expanded metal / Lamiera stirata / Métal déployé / Expandido / Streckgitter	10 x 7 - 1,3		(mm)
Open area / Vuoto su pieno / Transparence / Transparencia / Durchlass	63		(%)
Weight / Peso / Poids / Peso / Gewicht	2,92		(Kg/m ²)
Thickness / Spessore / Épaisseur / Espesor / Stärke	1		(mm)

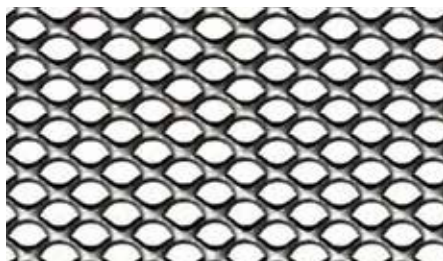

MODEL EQ - RD - 20 - Ø10

	LWD	SWD	ST
Expanded metal / Lamiera stirata / Métal déployé / Expandido / Streckgitter	20 x 15 - 3,2		(mm)
Open area / Vuoto su pieno / Transparence / Transparencia / Durchlass	57		(%)
Weight / Peso / Poids / Peso / Gewicht	3,35		(Kg/m ²)
Thickness / Spessore / Épaisseur / Espesor / Stärke	1		(mm)

***NOTE:** LIST OF MOST COMMON MESHES. ASK FOR OTHER MODELS OR THICKNESSES
 LISTA DELLE MAGLIE PIÙ COMUNI. ALTRI MODELLI O SPESSORI SU RICHIESTA
 LISTE DES MAILLES LES PLUS COMMUNES. DEMANDEZ D'AUTRES MODÈLES OU ÉPAISSEURS
 LISTADO DE MALLAS MÁS HABITUALES. OTROS MODELOS O ESPEORES CONSULTAR
 LISTE DER HÄUFIGSTEN STRECKGITTER. FRAGEN SIE NACH ANDEREN MODELLEN ODER STÄRKEN

MESH TYPES SQUARE

QUADRA / CARRÉES / CUADRADA / QUADRATISCH

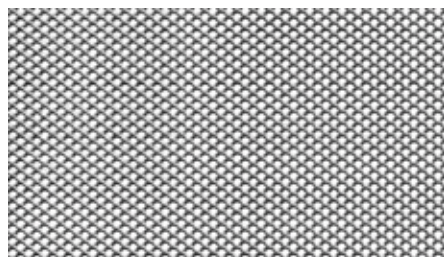
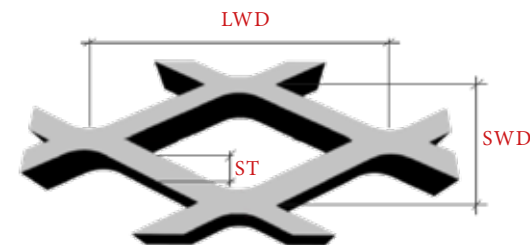

MODEL	EQ - Q - 5	LWD	SWD	ST	
Expanded metal / Lamiera stirata / Métal déployé / Expandido / Streckgitter		5	4	1	(mm)
Open area / Vuoto su pieno / Transparence / Transparencia / Durchlass		50			(%)
Weight / Peso / Poids / Peso / Gewicht		1,35			(Kg/m ²)
Thickness / Spessore / Épaisseur / Espesor / Stärke		1			(mm)



MODEL	EQ - Q - 10	LWD	SWD	ST	
Expanded metal / Lamiera stirata / Métal déployé / Expandido / Streckgitter		10	7,8	1	(mm)
Open area / Vuoto su pieno / Transparence / Transparencia / Durchlass		75			(%)
Weight / Peso / Poids / Peso / Gewicht		2,01			(Kg/m ²)
Thickness / Spessore / Épaisseur / Espesor / Stärke		1			(mm)

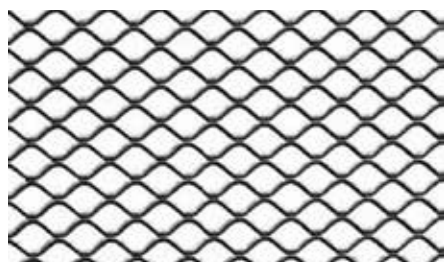

MODEL	EQ - Q - 16	LWD	SWD	ST	
Expanded metal / Lamiera stirata / Métal déployé / Expandido / Streckgitter		16	12	1,5	(mm)
Open area / Vuoto su pieno / Transparence / Transparencia / Durchlass		75			(%)
Weight / Peso / Poids / Peso / Gewicht		2,95			(Kg/m ²)
Thickness / Spessore / Épaisseur / Espesor / Stärke		1,5			(mm)

20092

***NOTE:** LIST OF MOST COMMON MESHES. ASK FOR OTHER MODELS OR THICKNESSES
 LISTA DELLE MAGLIE PIÙ COMUNI. ALTRI MODELLI O SPESSORI SU RICHIESTA
 LISTE DES MAILLES LES PLUS COMMUNES. DEMANDEZ D'AUTRES MODÈLES OU ÉPAISSEURS
 LISTADO DE MALLAS MÁS HABITUALES. OTROS MODELOS O ESPEORES CONSULTAR
 LISTE DER HÄUFIGSTEN STRECKGITTER. FRAGEN SIE NACH ANDEREN MODELLEN ODER STÄRKEN

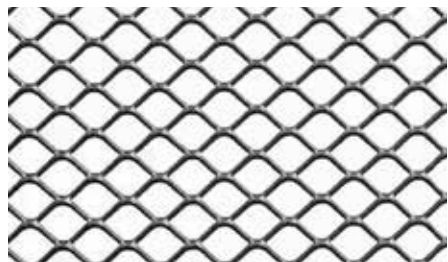

MODEL EQ - Q - 20	LWD	SWD	ST
Expanded metal / Lamiera stirata / Métal déployé / Expandido / Streckgitter	20	15	1,5 (mm)
Open area / Vuoto su pieno / Transparence / Transparencia / Durchlass	80		(%)
Weight / Peso / Poids / Peso / Gewicht	2,30		(Kg/m ²)
Thickness / Spessore / Épaisseur / Espesor / Stärke	1,5		(mm)



MODEL EQ - Q - 30	LWD	SWD	ST
Expanded metal / Lamiera stirata / Métal déployé / Expandido / Streckgitter	30	24	2 (mm)
Open area / Vuoto su pieno / Transparence / Transparencia / Durchlass	83		(%)
Weight / Peso / Poids / Peso / Gewicht	1,96		(Kg/m ²)
Thickness / Spessore / Épaisseur / Espesor / Stärke	1,5		(mm)



MODEL EQ - Q - 40	LWD	SWD	ST
Expanded metal / Lamiera stirata / Métal déployé / Expandido / Streckgitter	40	20	3 (mm)
Open area / Vuoto su pieno / Transparence / Transparencia / Durchlass	70		(%)
Weight / Peso / Poids / Peso / Gewicht	3,53		(Kg/m ²)
Thickness / Spessore / Épaisseur / Espesor / Stärke	1,5		(mm)



MODEL EQ - Q - 50	LWD	SWD	ST
Expanded metal / Lamiera stirata / Métal déployé / Expandido / Streckgitter	50	37	4,5 (mm)
Open area / Vuoto su pieno / Transparence / Transparencia / Durchlass	75		(%)
Weight / Peso / Poids / Peso / Gewicht	2,86		(Kg/m ²)
Thickness / Spessore / Épaisseur / Espesor / Stärke	1,5		(mm)

***NOTE:** LIST OF MOST COMMON MESHES. ASK FOR OTHER MODELS OR THICKNESSES
 LISTA DELLE MAGLIE PIÙ COMUNI. ALTRI MODELLI O SPESSORI SU RICHIESTA
 LISTE DES MAILLES LES PLUS COMMUNES. DEMANDEZ D'AUTRES MODÈLES OU ÉPAISSEURS
 LISTADO DE MALLAS MÁS HABITUALES. OTROS MODELOS O ESPEORES CONSULTAR
 LISTE DER HÄUFIGSTEN STRECKGITTER. FRAGEN SIE NACH ANDEREN MODELLEN ODER STÄRKEN

MESH TYPES

HEXAGONAL

ESAGONALE / HEXAGONALES / HEXAGONAL / SECHSECKIG

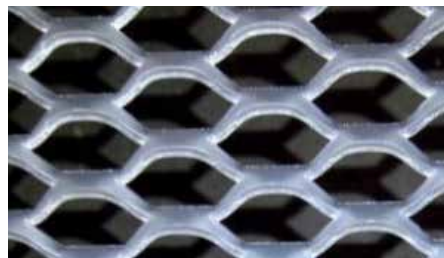
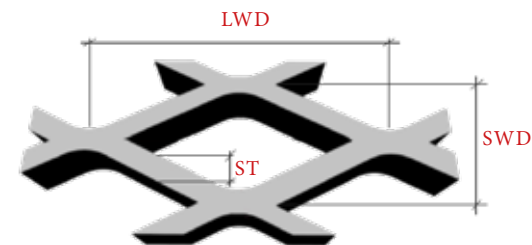

MODEL	EQ - HEX - 15	LWD	SWD	ST	
Expanded metal / Lamiera stirata / Métal déployé / Expandido / Streckgitter		45	18	4	(mm)
Open area / Vuoto su pieno / Transparence / Transparencia / Durchlass		56			(%)
Weight / Peso / Poids / Peso / Gewicht		5,24			(Kg/m ²)
Thickness / Spessore / Épaisseur / Espesor / Stärke		1,5			(mm)

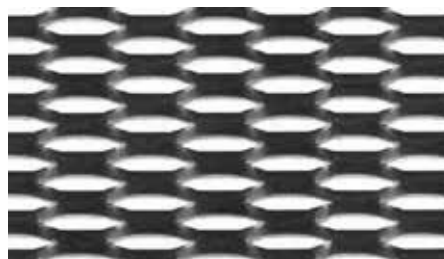

MODEL	EQ - HEX - 45	LWD	SWD	ST	
Expanded metal / Lamiera stirata / Métal déployé / Expandido / Streckgitter		45	13	5	(mm)
Open area / Vuoto su pieno / Transparence / Transparencia / Durchlass		24			(%)
Weight / Peso / Poids / Peso / Gewicht		9,07			(Kg/m ²)
Thickness / Spessore / Épaisseur / Espesor / Stärke		1,5			(mm)

2020

***NOTE:** LIST OF MOST COMMON MESHES. ASK FOR OTHER MODELS OR THICKNESSES
 LISTA DELLE MAGLIE PIÙ COMUNI. ALTRI MODELLI O SPESSORI SU RICHIESTA
 LISTE DES MAILLES LES PLUS COMMUNES. DEMANDEZ D'AUTRES MODÈLES OU ÉPAISSEURS
 LISTADO DE MALLAS MÁS HABITUALES. OTROS MODELOS O ESPORES CONSULTAR
 LISTE DER HÄUFIGSTEN STRECKGITTER. FRAGEN SIE NACH ANDEREN MODELLEN ODER STÄRKEN



CEILING TILES PANNELLI PER CONTROSOFFITTI
DALLES PLAFONDS
CANTOS
DECKENPLATTEN

LAY-IN SYSTEM

IN APPOGGIO / SUSPENDU-T
/ APOYADO / AUFGELEGT

Reference	Riferimento / Référence / Referencia / Referenz	SP
Profile	Profilo / Profil / Perfil / Profil	15/24/35
Support	Supporto / Support / Apoyo / Unterstützung	4L
Reinforcement	Rinforzo / Renfort / Refuerzo / Verstärkung	NO
Width (mm)	Larghezza / Largeur / Ancho / Breite	400/600/1000/1200
Length (mm)	Lunghezza / Longueur / Largo / Länge	400/600/1000/1200



***NOTE: FIXING SYSTEM RECOMMENDED, IN NO CASE IS IT BINDING**
SISTEMA DI MONTAGGIO CONSIGLIATO, IN NESSUN CASO VINCOLANTE / SYSTÈME DE MONTAGE RECOMMANDÉ, EN AUCUN CAS CONTRACTUEL / SISTEMA DE MONTAJE RECOMENDADO, EN NINGÚN CASO CONTRACTUAL / BEFESTIGUNGSSYSTEM EMPFOHLEN, IN KEINEM FALL VERBINDLICH

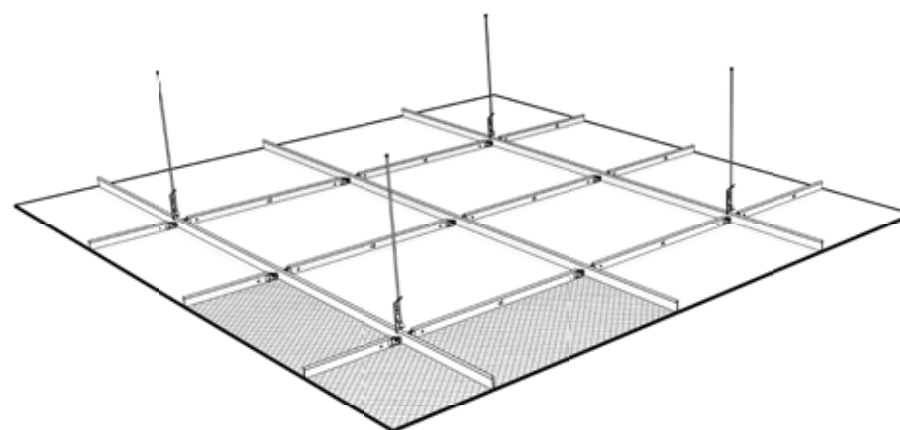
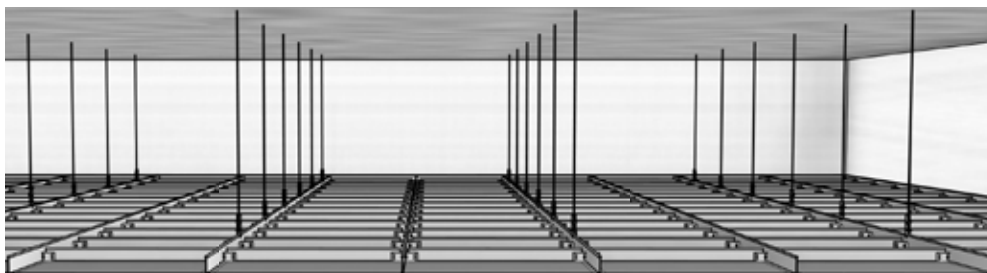

***NOTE: FIXING SYSTEM RECOMMENDED, IN NO CASE IS IT BINDING**
SISTEMA DI MONTAGGIO CONSIGLIATO, IN NESSUN CASO VINCOLANTE / SYSTÈME DE MONTAGE RECOMMANDÉ, EN AUCUN CAS CONTRACTUEL / SISTEMA DE MONTAJE RECOMENDADO, EN NINGÚN CASO CONTRACTUAL / BEFESTIGUNGSSYSTEM EMPFOHLEN, IN KEINEM FALL VERBINDLICH

ACCESSORIES

ACCESSORI / ACCESSOIRES / ACCESORIOS / ZUBEHÖR

SYSTEM SP

T PROFILE

PROFILO A T / PROFIL EN T / PERFIL T / T PROFIL

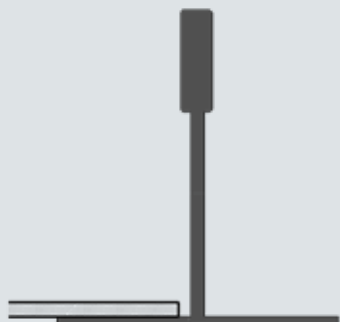

CEILING TILES

PANNELLI CONTROSOFFITTI / DALLES PLAFOND / CANTOS / DECKENPLATTEN

CONSUMPTION CONSUMO / CONSOMMATIONS / CONSUMO / VERBRAUCH

	600 x 600	1200 x 600
Panels	2,8 ud./m ²	1,40 ud./m ²
a - Primary profile	0,84 ml/m ²	0,84 ml/m ²
b - Secondary profile	1,67 ml/m ²	1,67 ml/m ²
c - Angular profile	0,60 ml/m ²	0,60 ml/m ²
d - Rod	0,67 ml/m ²	0,67 ml/m ²

MODULE SIZES (mm) MODULI / MODULES / MODULACIONES / MODULGRÖßEN

400 / 600 / 1000 / 1200 x 400 / 600 / 1000 / 1200

***NOTE: CUSTOM-MADE UPON REQUEST.**

POSSIBILE PRODURRE SU MISURA
FABRICATION SUR MESURE SUR COMMANDE
BAJO PEDIDO SE PUEDEN FABRICAR A MEDIDA
UNTER AUFTRAG KANN NACH MASS SEIN.

RECOMMENDED ITEMS

ARTICOLI CONSIGLIATI / ARTICLES RECOMMANDÉS
ELEMENTOS RECOMENDADOS / EMPFOHLENE ARTIKEL

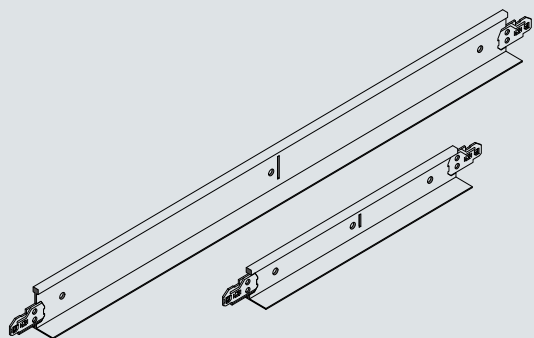

a - Primary Profile
Profilo primario
Profil primaire
Perfil primario
Primärprofil

b - Secondary Profile
Profilo secundario
Profil secondaire
Perfil secundario
Sekundärprofil

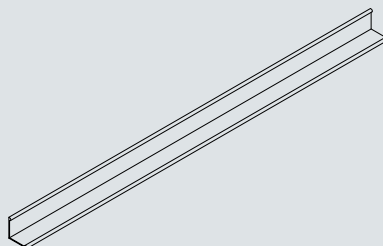

c - Angular Profile
Profilo angolare
Profil angulaire
Perfil angular
Winkelprofil

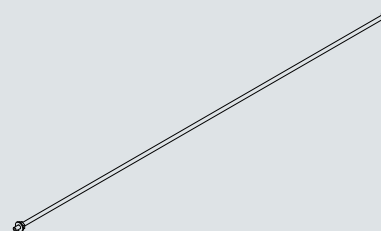

d - Rod
Asta
Tige
Varilla
Stange



e - Hanger
Gancio
Crochet
Pieza cuelgue
Schnellabhänger

***NOTE: FIXING SYSTEM RECOMMENDED, IN NO CASE IS IT BINDING**

SISTEMA DI MONTAGGIO CONSIGLIATO, IN NESSUN CASO VINCOLANTE / SYSTÈME DE MONTAGE RECOMMANDÉ, EN AUCUN CAS CONTRACTUEL / SISTEMA DE MONTAJE RECOMENDADO, EN NINGÚN CASO CONTRACTUAL / BEFESTIGUNGSSYSTEM EMPFOHLEN, IN KEINEM FALL VERBINDLICH

LAY-IN BENT SYSTEM

A FILO / AFFLEURÉ
/ ENRASADOS / BÜNDIG

Reference	Riferimento / Référence / Referencia / Referenz	FL
Profile	Profilo / Profil / Perfil / Profil	15/24/35
Support	Supporto / Support / Apoyo / Unterstützung	4L
Reinforcement	Rinforzo / Renfort / Refuerzo / Verstärkung	NO
Width (mm)	Larghezza / Largeur / Ancho / Breite	600/1200
Length (mm)	Lunghezza / Longueur / Largo / Länge	600

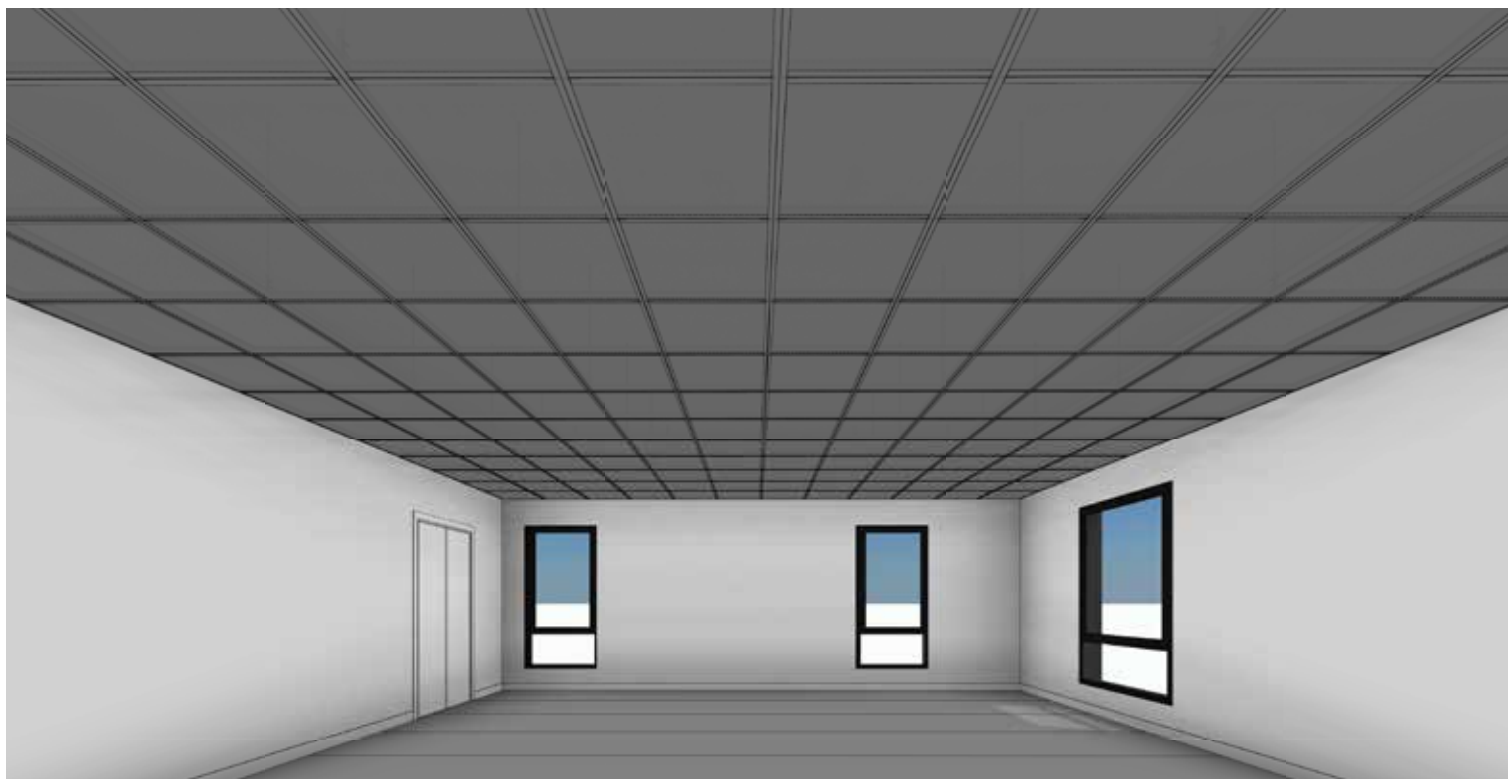

***NOTE: FIXING SYSTEM RECOMMENDED, IN NO CASE IS IT BINDING**
SISTEMA DI MONTAGGIO CONSIGLIATO, IN NESSUN CASO VINCOLANTE / SYSTÈME DE MONTAGE RECOMMANDÉ, EN AUCUN CAS CONTRACTUEL / SISTEMA DE MONTAJE RECOMENDADO, EN NINGÚN CASO CONTRACTUAL / BEFESTIGUNGSSYSTEM EMPFOHLEN, IN KEINEM FALL VERBINDLICH

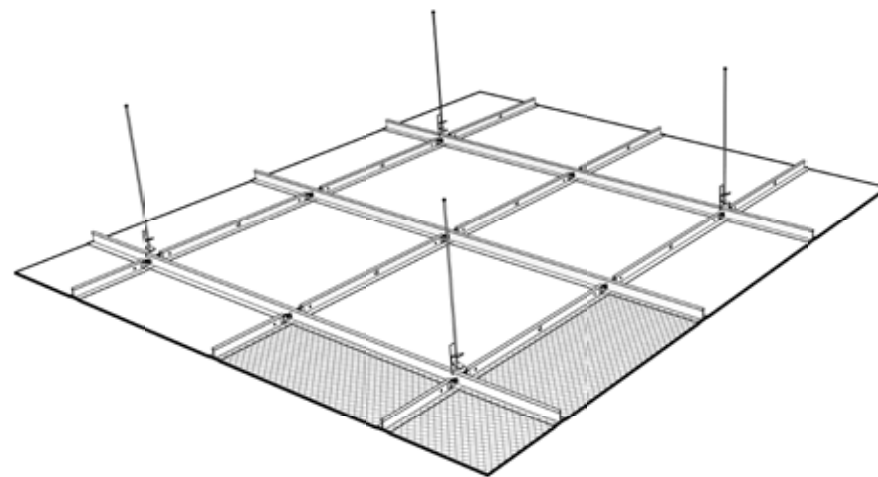
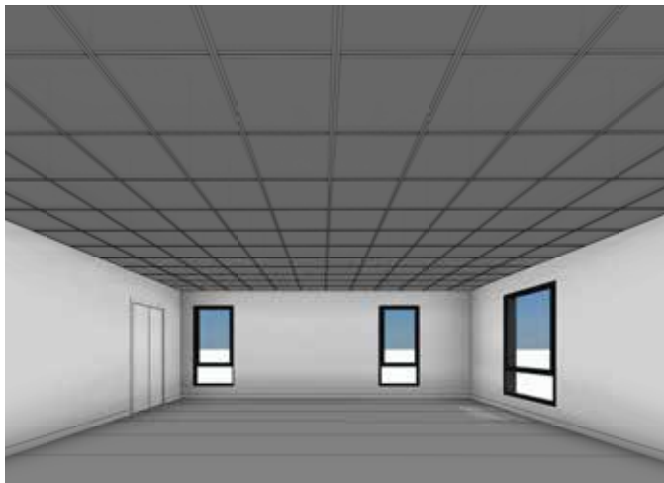

***NOTE: FIXING SYSTEM RECOMMENDED, IN NO CASE IS IT BINDING**
SISTEMA DI MONTAGGIO CONSIGLIATO, IN NESSUN CASO VINCOLANTE / SYSTÈME DE MONTAGE RECOMMANDÉ, EN AUCUN CAS CONTRACTUEL / SISTEMA DE MONTAJE RECOMENDADO, EN NINGÚN CASO CONTRACTUAL / BEFESTIGUNGSSYSTEM EMPFOHLEN, IN KEINEM FALL VERBINDLICH

ACCESSORIES

ACCESSORI / ACCESSOIRES / ACCESORIOS / ZUBEHÖR

SYSTEM FL

T PROFILE

PROFILO A T / PROFIL EN T / PERFIL T / T PROFIL

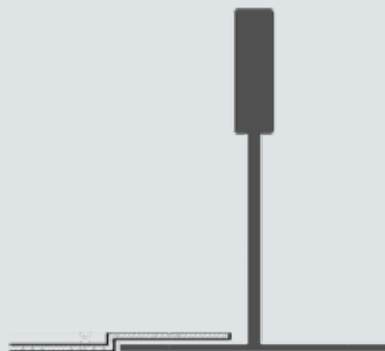

RECOMMENDED ITEMS

ARTICOLI CONSIGLIATI / ARTICLES RECOMMANDÉS
ELEMENTOS RECOMENDADOS / EMPFOHLENE ARTIKEL

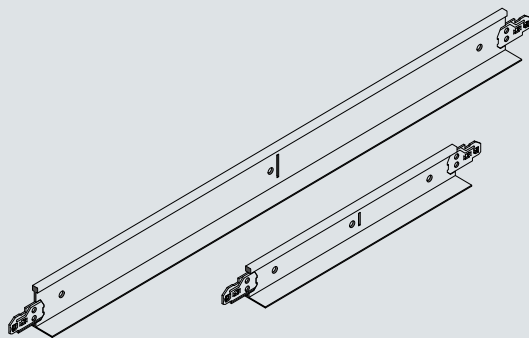

a - Primary Profile
Profilo primario
Profil primaire
Perfil primario
Primärprofil

b - Secondary Profile
Profilo secundario
Profil secondaire
Perfil secundario
Sekundärprofil

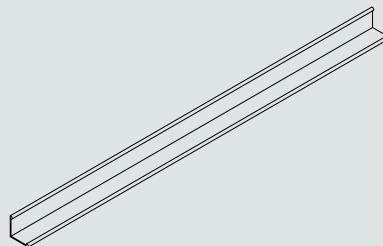

c - Angular Profile
Profilo angolare
Profil angulaire
Perfil angular
Winkelprofil

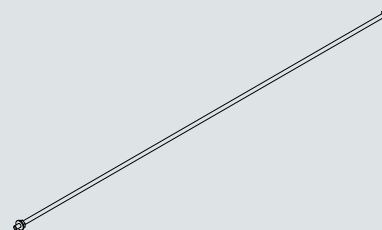

d - Rod
Asta
Tige
Varilla
Stange



e - Hanger
Gancio
Crochet
Pieza cuelgue
Schnellabhänger

CEILING TILES

PANNELLI CONTROSOFFITTI / DALLES PLAFOND / CANTOS / DECKENPLATTEN

CONSUMPTION CONSUMO / CONSOMMATIONS / CONSUMO / VERBRAUCH

	600 x 600	1200 x 600
Panels	2,8 ud./m ²	1,40 ud./m ²
a - Primary profile	0,84 ml/m ²	0,84 ml/m ²
b - Secondary profile	1,67 ml/m ²	1,67 ml/m ²
c - Angular profile	0,60 ml/m ²	0,60 ml/m ²
d - Rod	0,67 ml/m ²	0,67 ml/m ²

MODULE SIZES (mm) MODULI / MODULES / MODULACIONES / MODULGRÖßEN

600 / 1200 x 600

*NOTE: CUSTOM-MADE UPON REQUEST.

POSSIBILE PRODURRE SU MISURA
FABRICATION SUR MESURE SUR COMMANDE
BAJO PEDIDO SE PUEDEN FABRICAR A MEDIDA
UNTER AUFTRAG KANN NACH MASS SEIN.

*NOTE: FIXING SYSTEM RECOMMENDED, IN NO CASE IS IT BINDING

SISTEMA DI MONTAGGIO CONSIGLIATO, IN NESSUN CASO VINCOLANTE / SYSTÈME DE MONTAGE RECOMMANDÉ, EN AUCUN CAS CONTRACTUEL / SISTEMA DE MONTAJE RECOMENDADO, EN NINGÚN CASO CONTRACTUAL / BEFESTIGUNGSSYSTEM EMPFOHLEN, IN KEINEM FALL VERBINDLICH

LAY-OUT SYSTEM

RIBASSATI / TÉGULAIRE
/ TEGULARES / MIT GEFALZTEN KANTEN

Reference	Riferimento / Référence / Referencia / Referenz	TG
Profile	Profilo / Profil / Perfil / Profil	15/24/35
Support	Supporto / Support / Apoyo / Unterstützung	4L
Reinforcement	Rinforzo / Renfort / Refuerzo / Verstärkung	NO
Width (mm)	Larghezza / Largeur / Ancho / Breite	600/1200
Length (mm)	Lunghezza / Longueur / Largo / Länge	600



***NOTE: FIXING SYSTEM RECOMMENDED, IN NO CASE IS IT BINDING**
SISTEMA DI MONTAGGIO CONSIGLIATO, IN NESSUN CASO VINCOLANTE / SYSTÈME DE MONTAGE RECOMMANDÉ, EN AUCUN CAS CONTRACTUEL / SISTEMA DE MONTAJE RECOMENDADO, EN NINGÚN CASO CONTRACTUAL / BEFESTIGUNGSSYSTEM EMPFOHLEN, IN KEINEM FALL VERBINDLICH

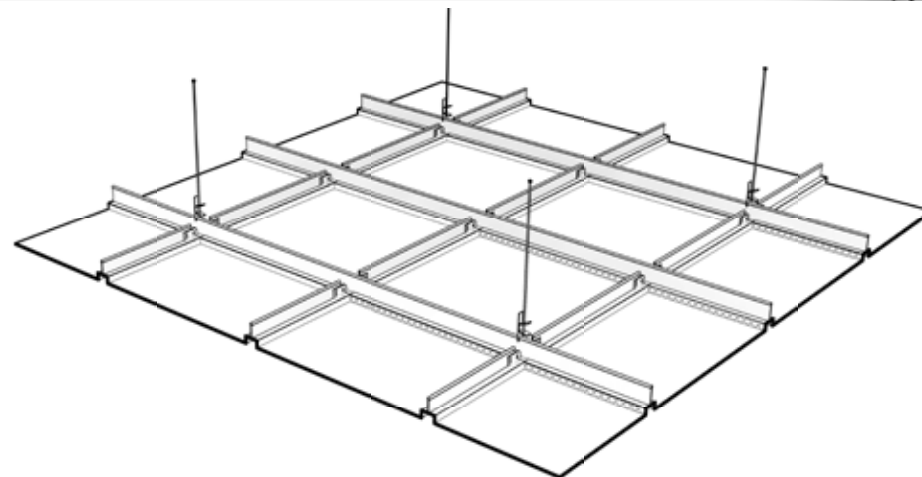
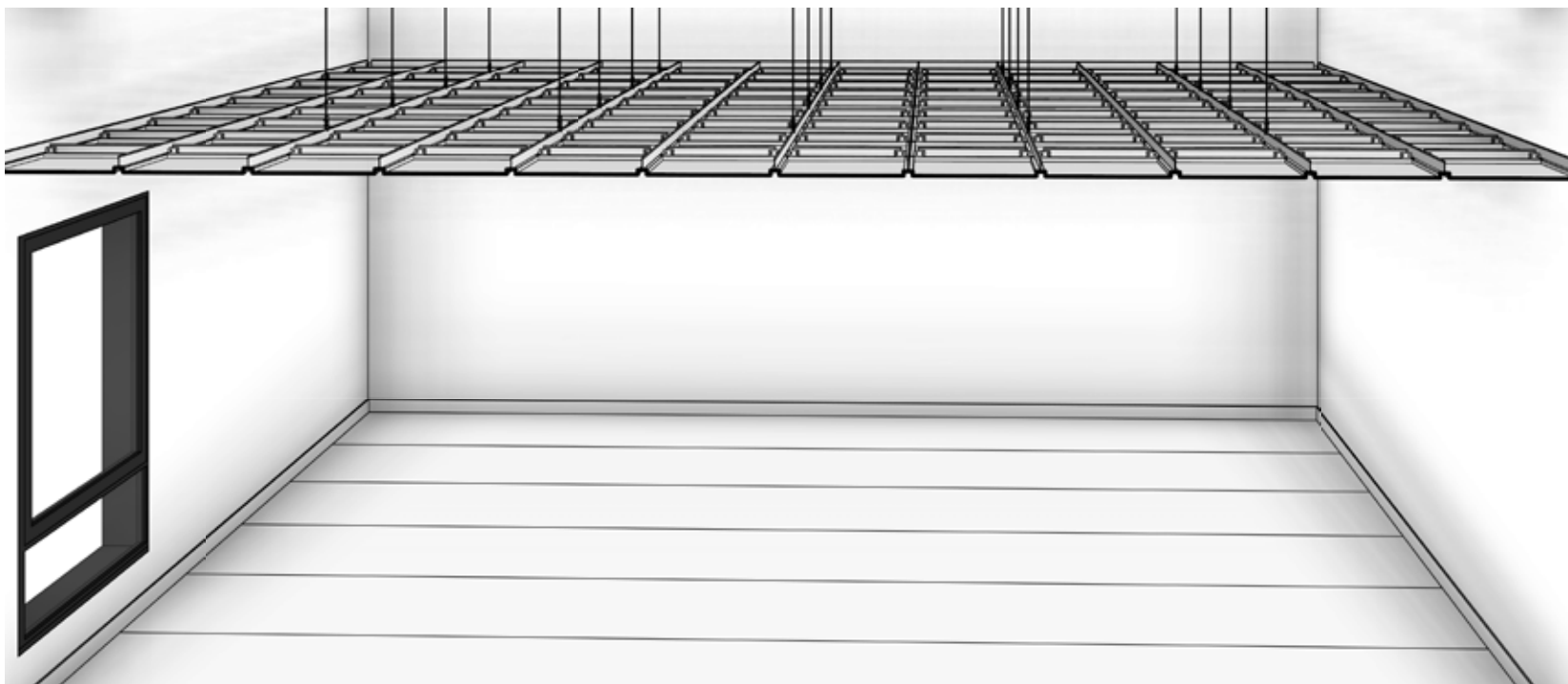

***NOTE: FIXING SYSTEM RECOMMENDED, IN NO CASE IS IT BINDING**
SISTEMA DI MONTAGGIO CONSIGLIATO, IN NESSUN CASO VINCOLANTE / SYSTÈME DE MONTAGE RECOMMANDÉ, EN AUCUN CAS
CONTRACTUEL / SISTEMA DE MONTAJE RECOMENDADO, EN NINGÚN CASO CONTRACTUAL / BEFESTIGUNGSSYSTEM EMPFOHLEN, IN
KEINEM FALL VERBINDLICH

ACCESSORIES

ACCESSORI / ACCESSOIRES / ACCESORIOS / ZUBEHÖR

SYSTEM TG

T PROFILE

PROFILO A T / PROFIL EN T / PERFIL T / T PROFIL

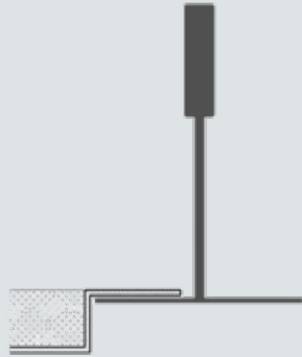

CEILING TILES

PANNELLI CONTROSOFFITTI / DALLES PLAFOND / CANTOS / DECKENPLATTEN

CONSUMPTION CONSUMO / CONSOMMATIONS / CONSUMO / VERBRAUCH

	600 x 600	1200 x 600
Panels	2,8 ud./m ²	1,40 ud./m ²
a - Primary profile	0,84 ml/m ²	0,84 ml/m ²
b - Secondary profile	1,67 ml/m ²	1,67 ml/m ²
c - Angular profile	0,60 ml/m ²	0,60 ml/m ²
d - Rod	0,67 ml/m ²	0,67 ml/m ²

MODULE SIZES (mm) MODULI / MODULES / MODULACIONES / MODULGRÖßEN

600 / 1200 x 600

RECOMMENDED ITEMS

ARTICOLI CONSIGLIATI / ARTICLES RECOMMANDÉS
ELEMENTOS RECOMENDADOS / EMPFOHLENE ARTIKEL

*NOTE: CUSTOM-MADE UPON REQUEST.

POSSIBILE PRODURRE SU MISURA
FABRICATION SUR MESURE SUR COMMANDE
BAJO PEDIDO SE PUEDEN FABRICAR A MEDIDA
UNTER AUFTRAG KANN NACH MASS SEIN.

2020

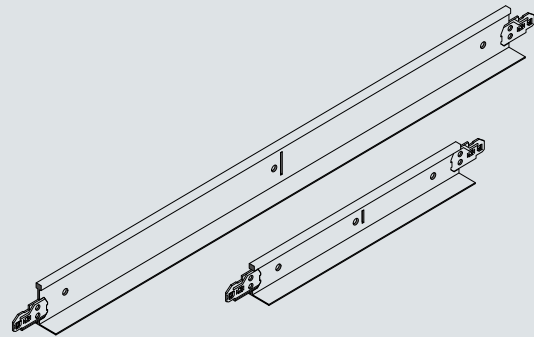

a - Primary Profile
Profilo primario
Profil primaire
Perfil primario
Primärprofil

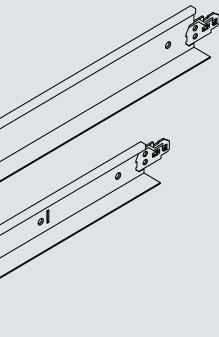

b - Secondary Profile
Profilo secundario
Profil secondaire
Perfil secundario
Sekundärprofil

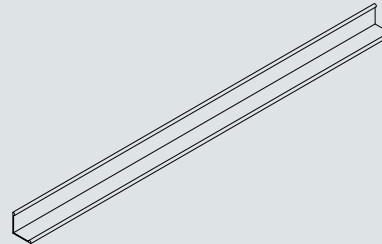

c - Angular Profile
Profilo angolare
Profil angulaire
Perfil angular
Winkelprofil

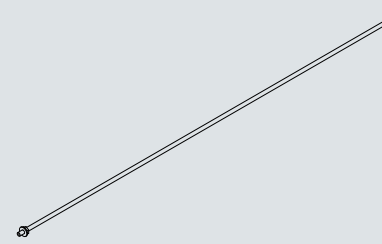

d - Rod
Asta
Tige
Varilla
Stange



e - Hanger
Gancio
Crochet
Pieza cuelgue
Schnellabhänger

*NOTE: FIXING SYSTEM RECOMMENDED, IN NO CASE IS IT BINDING

SISTEMA DI MONTAGGIO CONSIGLIATO, IN NESSUN CASO VINCOLANTE / SYSTÈME DE MONTAGE RECOMMANDÉ, EN AUCUN CAS CONTRACTUEL / SISTEMA DE MONTAJE RECOMENDADO, EN NINGÚN CASO CONTRACTUAL / BEFESTIGUNGSSYSTEM EMPFOHLEN, IN KEINEM FALL VERBINDLICH

FSP SYSTEM

Reference	Riferimento / Référence / Referencia / Referenz	CCP
Profile	Profilo / Profil / Perfil / Profil	T/OMEGA
Support	Supporto / Support / Apoyo / Unterstützung	CL
Reinforcement	Rinforzo / Renfort / Refuerzo / Verstärkung	NO
Width (mm)	Larghezza / Largeur / Ancho / Breite	600
Length (mm)	Lunghezza / Longueur / Largo / Länge	600/1200



***NOTE: FIXING SYSTEM RECOMMENDED, IN NO CASE IS IT BINDING**
SISTEMA DI MONTAGGIO CONSIGLIATO, IN NESSUN CASO VINCOLANTE / SYSTÈME DE MONTAGE RECOMMANDÉ, EN AUCUN CAS CONTRACTUEL / SISTEMA DE MONTAJE RECOMENDADO, EN NINGÚN CASO CONTRACTUAL / BEFESTIGUNGSSYSTEM EMPFOHLEN, IN KEINEM FALL VERBINDLICH

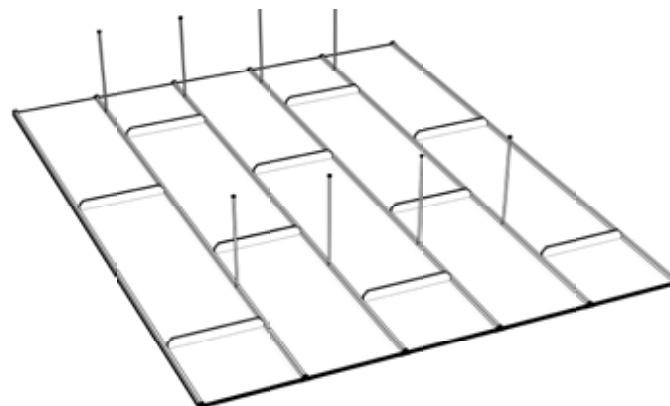
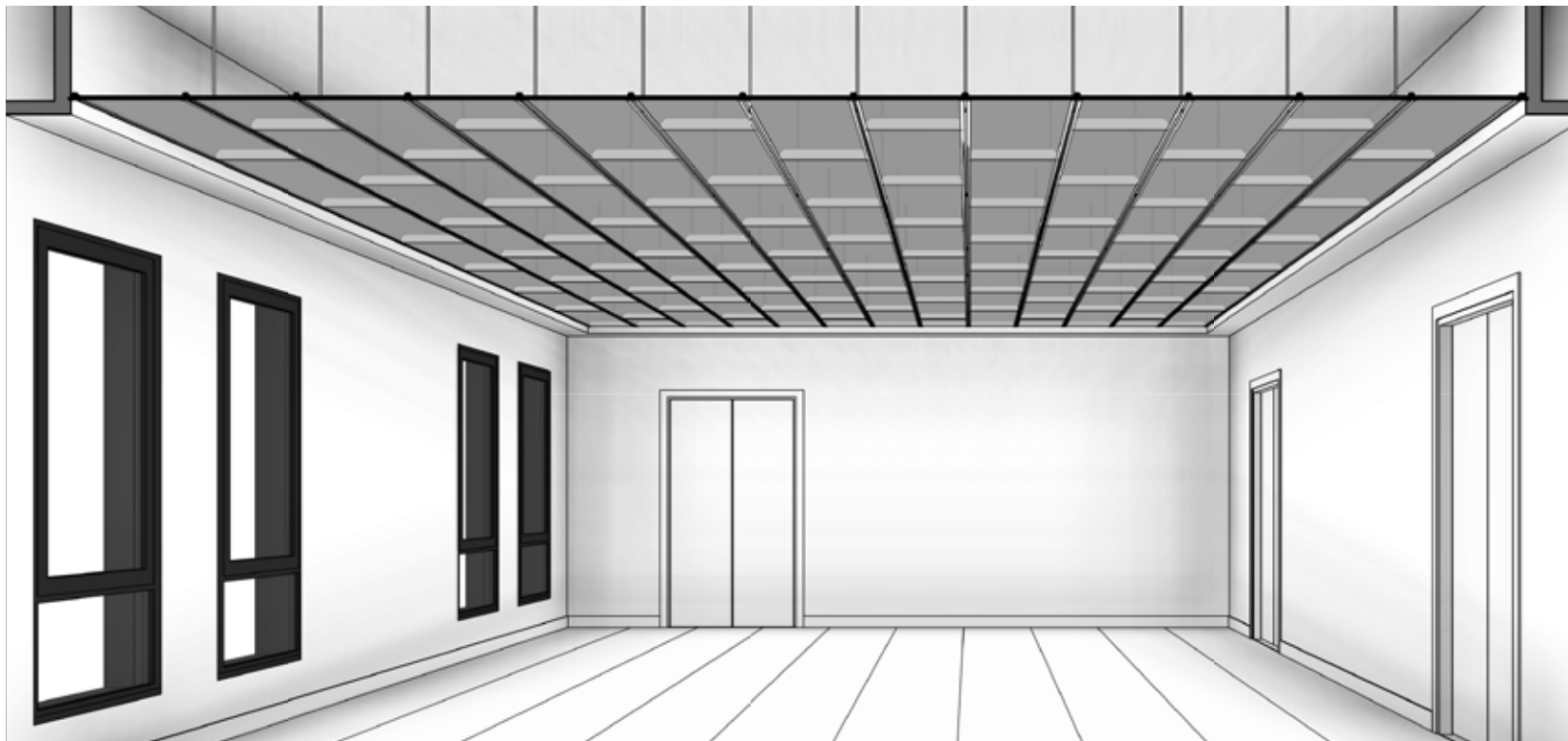

*NOTE: FIXING SYSTEM RECOMMENDED, IN NO CASE IS IT BINDING
SISTEMA DI MONTAGGIO CONSIGLIATO, IN NESSUN CASO VINCOLANTE / SYSTÈME DE MONTAGE RECOMMANDÉ, EN AUCUN CAS
CONTRACTUEL / SISTEMA DE MONTAJE RECOMENDADO, EN NINGÚN CASO CONTRACTUAL / BEFESTIGUNGSSYSTEM EMPFOHLEN, IN
KEINEM FALL VERBINDLICH

ACCESSORIES

ACCESSORI / ACCESSOIRES / ACCESORIOS / ZUBEHÖR

FSP SYSTEM

T PROFILE

PROFILO A T / PROFIL EN T / PERFIL T / T PROFIL

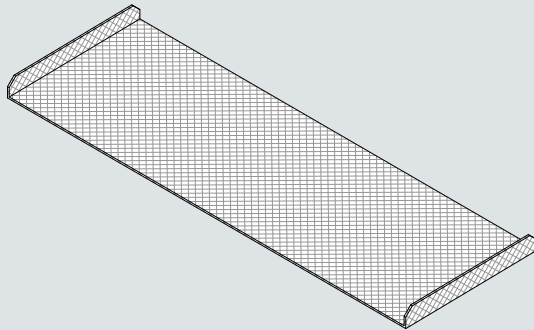

CEILING TILES

PANNELLI CONTROSOFFITTI / DALLES PLAFOND / CANTOS / DECKENPLATTEN

UPON REQUEST

/ SU RICHIESTA / CONSULTER / CONSULTAR / AUF ANFRAGE

MODULE SIZES (mm) MODULI / MODULES / MODULACIONES / MODULGRÖßEN

600 / 1200 / 1500 / 2000 x 600 / 1000

***NOTE: CUSTOM-MADE UPON REQUEST.**

POSSIBILE PRODURRE SU MISURA
FABRICATION SUR MESURE SUR COMMANDE
BAJO PEDIDO SE PUEDEN FABRICAR A MEDIDA
UNTER AUFTRAG KANN NACH MASS SEIN.

RECOMMENDED ITEMS

ARTICOLI CONSIGLIATI / ARTICLES RECOMMANDÉS / ELEMENTOS RECOMENDADOS / EMPFOHLENE ARTIKEL

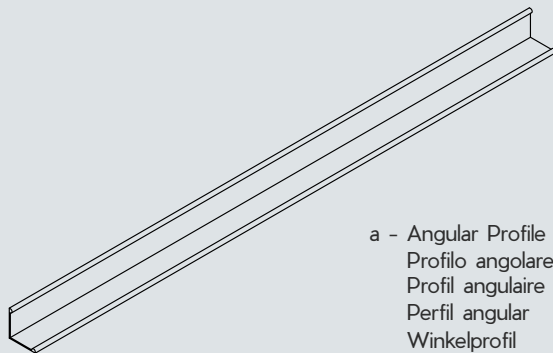

a - Angular Profile
Profilo angolare
Profil angulaire
Perfil angular
Winkelprofil

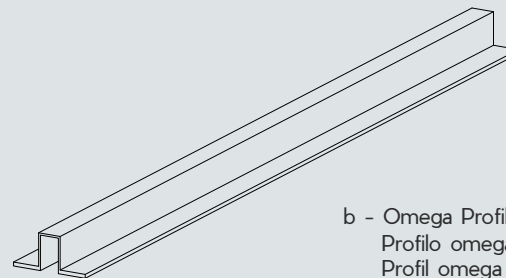

b - Omega Profile
Profilo omega
Profil omega
Perfil omega
Omega-Profil

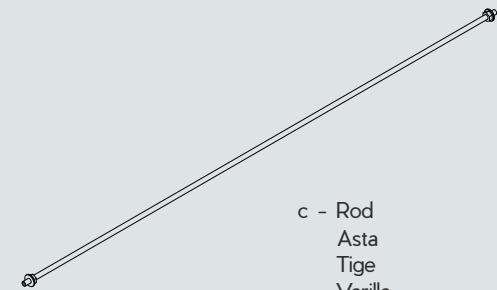

c - Rod
Asta
Tige
Varilla
Stange

***NOTE: FIXING SYSTEM RECOMMENDED, IN NO CASE IS IT BINDING**

SISTEMA DI MONTAGGIO CONSIGLIATO, IN NESSUN CASO VINCOLANTE / SYSTÈME DE MONTAGE RECOMMANDÉ, EN AUCUN CAS CONTRACTUEL / SISTEMA DE MONTAJE RECOMENDADO, EN NINGÚN CASO CONTRACTUAL / BEFESTIGUNGSSYSTEM EMPFOHLEN, IN KEINEM FALL VERBINDLICH

FLP SYSTEM

Reference	Riferimento / Référence / Referencia / Referenz	CLP/PANEL PASILLO
Profile	Profilo / Profil / Perfil / Profil	T/L
Support	Supporto / Support / Apoyo / Unterstützung	CL
Reinforcement	Rinforzo / Renfort / Refuerzo / Verstärkung	NO/SÍ
Width (mm)	Larghezza / Largeur / Ancho / Breite	600
Length (mm)	Lunghezza / Longueur / Largo / Länge	600/1200



***NOTE: FIXING SYSTEM RECOMMENDED, IN NO CASE IS IT BINDING**
SISTEMA DI MONTAGGIO CONSIGLIATO, IN NESSUN CASO VINCOLANTE / SYSTÈME DE MONTAGE RECOMMANDÉ, EN AUCUN CAS CONTRACTUEL / SISTEMA DE MONTAJE RECOMENDADO, EN NINGÚN CASO CONTRACTUAL / BEFESTIGUNGSSYSTEM EMPFOHLEN, IN KEINEM FALL VERBINDLICH

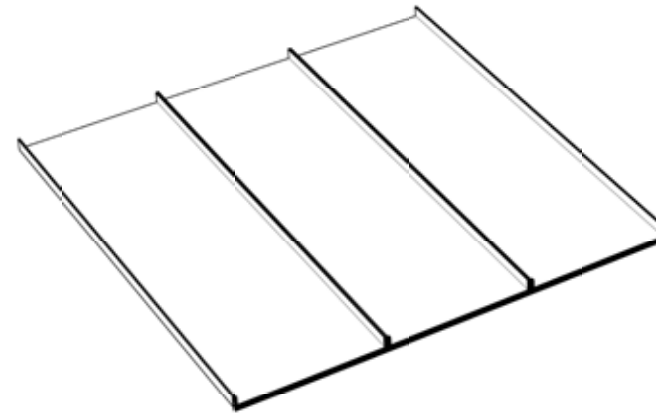
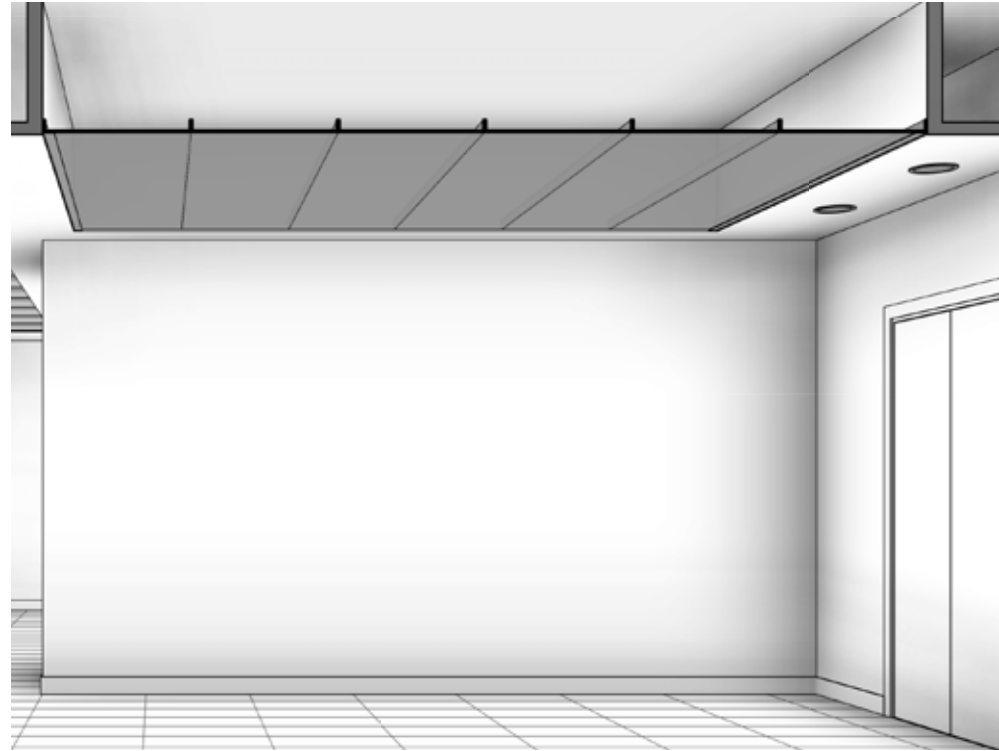

PANNELLI CONTROSOFITTI / DALLES PLAFOND / CANTOS / DECKENPLATTEN

***NOTE: FIXING SYSTEM RECOMMENDED, IN NO CASE IS IT BINDING**
SISTEMA DI MONTAGGIO CONSIGLIATO, IN NESSUN CASO VINCOLANTE / SYSTÈME DE MONTAGE RECOMMANDÉ, EN AUCUN CAS CONTRACTUEL / SISTEMA DE MONTAJE RECOMENDADO, EN NINGÚN CASO CONTRACTUAL / BEFESTIGUNGSSYSTEM EMPFOHLEN, IN KEINEM FALL VERBINDLICH

ACCESSORIES

ACCESSORI / ACCESSOIRES / ACCESORIOS / ZUBEHÖR

FLP SYSTEM

T PROFILE

PROFILO A T / PROFIL EN T / PERFIL T / T PROFIL

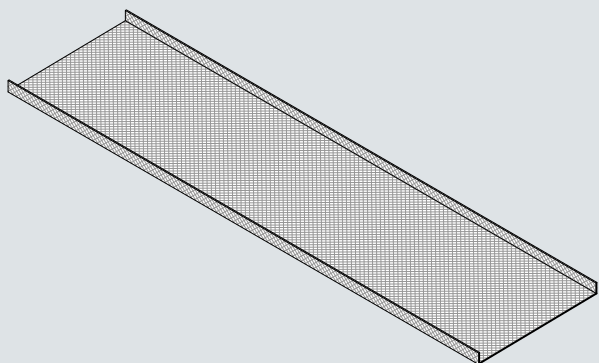

CEILING TILES

PANNELLI CONTROSOFFITTI / DALLES PLAFOND / CANTOS / DECKENPLATTEN

CONSUMPTION CONSUMO / CONSOMMATIONS / CONSUMO / VERBRAUCH

UPON REQUEST

/ SU RICHIESTA / CONSULTER / CONSULTAR / AUF ANFRAGE

MODULE SIZES (mm) MODULI / MODULES / MODULACIONES / MODULGRÖßEN

600 / 1200 x 600

***NOTE: CUSTOM-MADE UPON REQUEST.**

POSSIBILE PRODURRE SU MISURA
FABRICATION SUR MESURE SUR COMMANDE
BAJO PEDIDO SE PUEDEN FABRICAR A MEDIDA
UNTER AUFTRAG KANN NACH MASS SEIN.

RECOMMENDED ITEMS

ARTICOLI CONSIGLIATI / ARTICLES RECOMMANDÉS / ELEMENTOS RECOMENDADOS / EMPFOHLENE ARTIKEL

En función del tipo de instalación pondremos perfil y pletina de refuerzo.

UPON REQUEST

/ SU RICHIESTA / CONSULTER

/ CONSULTAR / AUF ANFRAGE

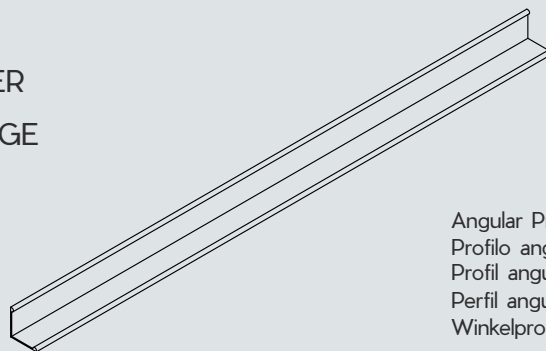

Angular Profile
Profilo angolare
Profil angulaire
Perfil angular
Winkelprofil

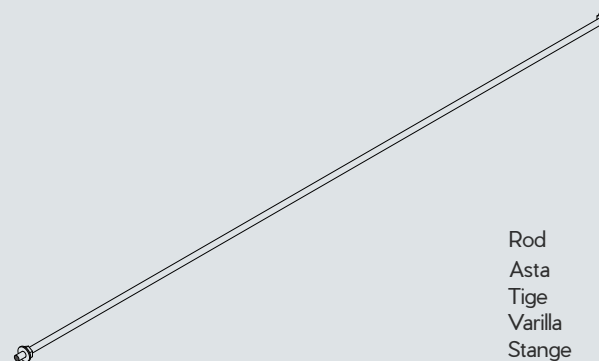

Rod
Asta
Tige
Varilla
Stange

***NOTE: FIXING SYSTEM RECOMMENDED, IN NO CASE IS IT BINDING**

SISTEMA DI MONTAGGIO CONSIGLIATO, IN NESSUN CASO VINCOLANTE / SYSTÈME DE MONTAGE RECOMMANDÉ, EN AUCUN CAS CONTRACTUEL / SISTEMA DE MONTAJE RECOMENDADO, EN NINGÚN CASO CONTRACTUAL / BEFESTIGUNGSSYSTEM EMPFOHLEN, IN KEINEM FALL VERBINDLICH

HP SYSTEM

Reference	Riferimento / Référence / Referencia / Referenz	OC
Profile	Profilo / Profil / Perfil / Profil	CLIP
Support	Supporto / Support / Apoyo / Unterstützung	CL
Reinforcement	Rinforzo / Renfort / Refuerzo / Verstärkung	NO
Width (mm)	Larghezza / Largeur / Ancho / Breite	600
Length (mm)	Lunghezza / Longueur / Largo / Länge	600/1200



***NOTE: FIXING SYSTEM RECOMMENDED, IN NO CASE IS IT BINDING**
SISTEMA DI MONTAGGIO CONSIGLIATO, IN NESSUN CASO VINCOLANTE / SYSTÈME DE MONTAGE RECOMMANDÉ, EN AUCUN CAS CONTRACTUEL / SISTEMA DE MONTAJE RECOMENDADO, EN NINGÚN CASO CONTRACTUAL / BEFESTIGUNGSSYSTEM EMPFOHLEN, IN KEINEM FALL VERBINDLICH

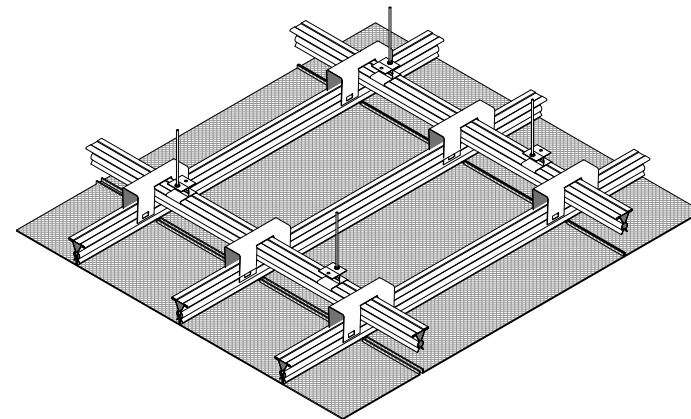

***NOTE: FIXING SYSTEM RECOMMENDED, IN NO CASE IS IT BINDING
SISTEMA DI MONTAGGIO CONSIGLIATO, IN NESSUN CASO VINCOLANTE / SYSTÈME DE MONTAGE RECOMMANDÉ, EN AUCUN CAS
CONTRACTUEL / SISTEMA DE MONTAJE RECOMENDADO, EN NINGÚN CASO CONTRACTUAL / BEFESTIGUNGSSYSTEM EMPFOHLEN, IN
KEINEM FALL VERBINDLICH**

ACCESSORIES

ACCESSORI / ACCESSOIRES / ACCESORIOS / ZUBEHÖR

HP SYSTEM

T PROFILE

PROFILO A T / PROFIL EN T / PERFIL T / T PROFIL

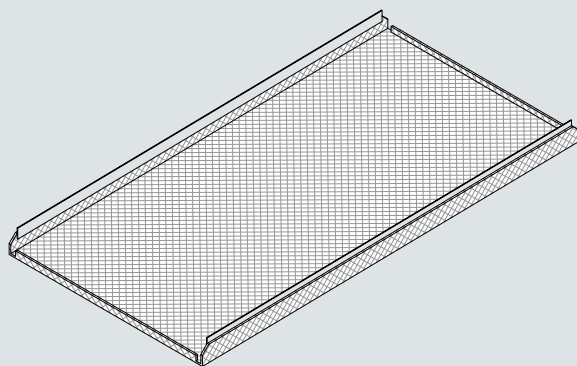

CEILING TILES

PANNELLI CONTROSOFFITTI / DALLES PLAFOND / CANTOS / DECKENPLATTEN

	600 x 600	1200 x 600
a - Panel	2,8 ud./m ²	1,40 ud./m ²
b - Triangular Profile	2,45 ml/m ²	1,60 ml/m ²
c - Fixing bracket	1,15 ud./m ²	1,55 ud./m ²
d - Hanger	0,70 ud./m ²	0,70 ud./m ²

MODULE SIZES (mm) MODULI / MODULES / MODULACIONES / MODULGRÖßEN

600 / 1200 x 600

***NOTE: CUSTOM-MADE UPON REQUEST.**

POSSIBILE PRODURRE SU MISURA
 FABRICATION SUR MESURE SUR COMMANDE
 BAJO PEDIDO SE PUEDEN FABRICAR A MEDIDA
 UNTER AUFTRAG KANN NACH MASS SEIN.

RECOMMENDED ITEMS

ARTICOLI CONSIGLIATI / ARTICLES RECOMMANDÉS / ELEMENTOS RECOMENDADOS / EMPFOHLENE ARTIKEL



Rod
Asta
Tige
Varilla
Stange

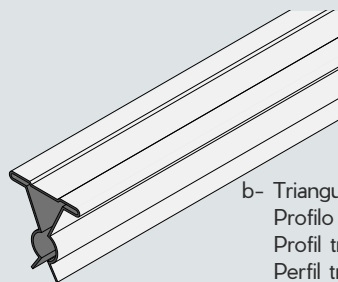

b- Triangular Profile
 Profilo triangolare
 Profil triangulaire
 Perfil triangular
 Dreiecksprofil

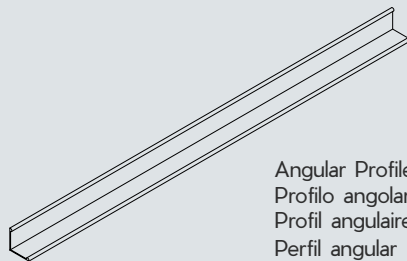

Angular Profile
 Profilo angolare
 Profil angulaire
 Perfil angular
 Winkelprofil

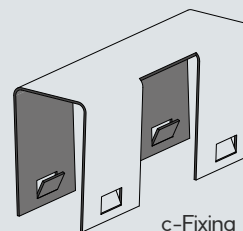

c-Fixing Bracket
 Staffa di fissaggio
 Support de fixation
 Perfil angular
 Montageklammer

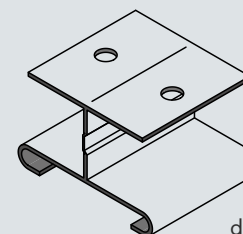

d - Hanger
 Gancio
 Pièce pour suspension
 Perfil angular
 Abhänger

***NOTE: FIXING SYSTEM RECOMMENDED, IN NO CASE IS IT BINDING**

SISTEMA DI MONTAGGIO CONSIGLIATO, IN NESSUN CASO VINCOLANTE / SYSTÈME DE MONTAGE RECOMMANDÉ, EN AUCUN CAS CONTRACTUEL / SISTEMA DE MONTAJE RECOMENDADO, EN NINGÚN CASO CONTRACTUAL / BEFESTIGUNGSSYSTEM EMPFOHLEN, IN KEINEM FALL VERBINDLICH



MATERIALS AND FINISHES

MATERIALI E FINITURE
MATÉRIAUX ET FINITIONS
MATERIALES Y ACABADOS
MATERIALIEN UND OBERFLÄCHEN

INSTALLATION REQUIREMENTS

REQUISITI DI INSTALLAZIONE
EXIGENCES D'INSTALLATION
REQUISITOS PREVIOS A LA INSTALACIÓN
INSTALLATIONSANFORDERUNGEN

The ceilings panels are placed in the last phase of construction, that is, when all doors and windows have already been installed and all connections have been placed.

I pannelli dei controsoffitti sono collocati nell'ultima fase della costruzione, cioè dopo aver posizionato tutti i serramenti ed installato i vari impianti.

Les panneaux de faux-plafonds sont placés dans la dernière phase de construction, c'est-à-dire lorsque toutes les menuiseries et les installations ont déjà été placées.

Los techos de bandejas metálicas se colocan en la última fase de construcción, es decir, cuando ya se han colocado todos los cerramientos y las instalaciones ya han sido ubicadas.

Die Paneele der Zwischendecke werden in der letzten Bauphase platziert, d. h. wenn alle Fenster und Türen bereits installiert und alle Anschlüsse schon verlegt sind.

- Install the ceiling in environmental conditions of temperature from 15 to 25 ° C and humidity from 35 to 75%.

- Installare il controsoffitto a condizioni ambientali con temperature tra i 15° e 25° C e umidità tra il 35 e il 75%.

- Installer le faux-plafond dans des conditions ambiantes de température de 15 à 25 ° C et d'humidité de 35 à 75%.

- Instalar el techo en condiciones ambientales de temperatura de 15 a 25 °C y de humedad del 35 al 75%.

- Installieren Sie die Decke bei Umgebungstemperaturen von 15 bis 25 ° C und Luftfeuchtigkeit von 35 bis 75%.

- The opening where the counter-ceiling shall be placed has to be clean and free of obstacles that hinder the installation procedure.

- È necessario che il vano in cui deve essere posizionato il controsoffitto sia pulito e privo di ostacoli che ne impediscano l'installazione.

- Il est nécessaire que l'ouverture dans laquelle le plafond doit être installé soit propre et exempte d'obstacles gênant la procédure d'installation.

- Es necesario que el recinto donde vaya colocarse el techo esté limpio y libre de obstáculos que dificulten el procedimiento de instalación.

- Die Öffnung, wo die Zwischendecke installiert werden soll, muss sauber und frei von Hindernissen sein, die den Installationsvorgang behindern könnten.

RAL - COLORS

COLORI - RAL
 COULEURS - RAL
 COLORES - RAL
 RAL - FARBEN

RAL 1000		RAL 4007		RAL 7008		RAL 2004		RAL 6005		RAL 8000	
RAL 1001		RAL 4008		RAL 7009		RAL 2008		RAL 6006		RAL 8001	
RAL 1002		RAL 4009		RAL 7010		RAL 2009		RAL 6007		RAL 8002	
RAL 1003		RAL 5000		RAL 7011		RAL 2010		RAL 6008		RAL 8003	
RAL 1004		RAL 5001		RAL 7012		RAL 2011		RAL 6009		RAL 8004	
RAL 1005		RAL 5002		RAL 7013		RAL 2012		RAL 6010		RAL 8007	
RAL 1006		RAL 5003		RAL 7015		RAL 3000		RAL 6011		RAL 8008	
RAL 1007		RAL 5004		RAL 7016		RAL 3001		RAL 6012		RAL 8011	
RAL 1011		RAL 5005		RAL 7021		RAL 3002		RAL 6013		RAL 8012	
RAL 1012		RAL 5007		RAL 7022		RAL 3003		RAL 6014		RAL 8014	
RAL 1013		RAL 5008		RAL 7023		RAL 3004		RAL 6015		RAL 8015	
RAL 1014		RAL 5009		RAL 7024		RAL 3005		RAL 6016		RAL 8016	
RAL 1015		RAL 5010		RAL 7026		RAL 3007		RAL 6017		RAL 8017	
RAL 1016		RAL 5011		RAL 7030		RAL 3009		RAL 6018		RAL 8019	
RAL 1017		RAL 5012		RAL 7031		RAL 3011		RAL 6019		RAL 8022	
RAL 1018		RAL 5013		RAL 7032		RAL 3012		RAL 6020		RAL 8023	
RAL 1019		RAL 5014		RAL 7033		RAL 3013		RAL 6021		RAL 8024	
RAL 1020		RAL 5015		RAL 7034		RAL 3014		RAL 6022		RAL 8025	
RAL 1021		RAL 5017		RAL 7035		RAL 3015		RAL 6024		RAL 8028	
RAL 1023		RAL 5018		RAL 7036		RAL 3016		RAL 6025		RAL 9001	
RAL 1024		RAL 5019		RAL 7037		RAL 3017		RAL 6026		RAL 9002	
RAL 1027		RAL 5020		RAL 7038		RAL 3018		RAL 6027		RAL 9003	
RAL 1028		RAL 5021		RAL 7039		RAL 3020		RAL 6028		RAL 9004	
RAL 1032		RAL 5022		RAL 7040		RAL 3022		RAL 6029		RAL 9005	
RAL 1033		RAL 5024		RAL 7042		RAL 3027		RAL 6032		RAL 9006	
RAL 1034		RAL 6000		RAL 7043		RAL 3031		RAL 7000		RAL 9007	
RAL 2000		RAL 6001		RAL 7040		RAL 4001		RAL 7001		RAL 9010	
RAL 2001		RAL 6002		RAL 7045		RAL 4002		RAL 7002		RAL 9011	
RAL 2002		RAL 6003		RAL 7046		RAL 4003		RAL 7003		RAL 9016	
RAL 2003		RAL 6004		RAL 7047		RAL 4004		RAL 7004		RAL 9017	
						RAL 4005		RAL 7005		RAL 9018	
						RAL 4006		RAL 7006			

*RAL color chart.

APPLICATIONS

APPLICAZIONI
APPLICATIONS
APLICACIONES
ANWENDUNGEN



Offices / Uffici / Bureaux / Oficinas / Büros

Shopping Malls / Centri commerciali / Centres commerciaux/ Centros Comerciales / Einkaufszentren

Health centers / Strutture sanitarie / Centres de santé / Centros de Salud / Gesundheitszentren

Stores / Negozi / Boutiques / Comercios / Geschäfte

Leisure facilities / Strutture ricreative / Centres de loisirs / Establecimientos de Ocio / Freizeiteinrichtungen

Sports facilities / Impianti sportivi / Installations sportives / Complejos Deportivos / Sportanlagen

Airports / Aeroporti / Aéroports / Aeropuertuarios / Flughäfen

In all those areas that require high aesthetics and high acoustic behavior.

In tutte quelle aree che richiedono un'estetica e una performance acustica elevate.

Dans tous les domaines qui exigent une haute esthétique et un comportement acoustique élevé.

En todas aquellas zonas que se requiera de una alta estética y un alto comportamiento acústico.

In allen Bereichen, die eine hohe Ästhetik und ein hohes akustisches Verhalten erfordern.

ACOUSTICS

ACUSTICA
ACOUSTIQUE
ACUSTICA
AKUSTIK



With honeycomb panels in fiberglass, rock wool, polymers or polyesters.

In combinazione con pannelli a nido d'ape in lana di vetro, lana di roccia, polimeri o poliesteri.

En combinaison avec des nids d'abeilles de laine de verre, de laine de roche, de polymères ou de polyesters.

En combinación con panales de lana de vidrio, lana de roca, polímeros o poliésteres.

Mit Wabenplatten aus Fiberglas, Steinwolle, Polymeren oder Polyestern.

MATERIALS

MATERIALI
MATÉRIAUX
MATERIALES
MATERIALIEN

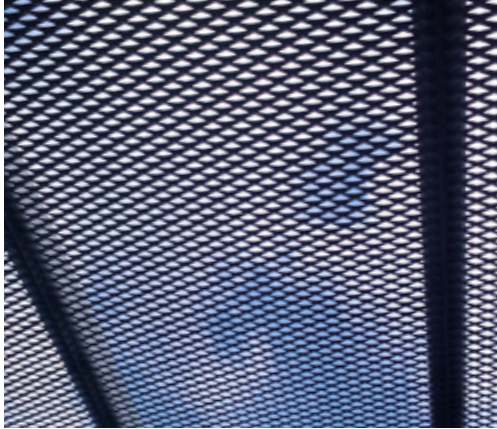

Steel / Acciaio / Acier / Acero / Stahl

Galvanised Steel / Acciaio Zincato / Acier Galvanisé / Acero Galvanizado / Verzinkter Stahl

Stainless Steel / Acciaio Inossidabile / Acier Inoxidable / Acero Inoxidable / Edelstahl

Corten Steel/ Acciaio Corten/ Acier Corten/ Acero Corten / Cortenstahl

Aluminum / Alluminio / Aluminium / Aluminio / Aluminium

*Please contact us for other materials.

FINISHES

FINITURE
FINITIONS
ACABADOS
OBERFLÄCHEN

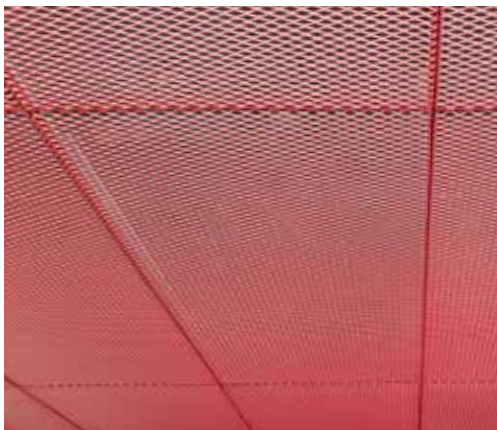

Mill finish / Grezzo / Brut / Natural / Roh

Powder-coated / Verniciato / Laqué / Lacado / Lackiert

Anodized / Anodizzato / Anodisé / Anodizado / Eloxiert

Engraved / Inciso / Gravé / Grabado / Graviert

MECHANIZATION

MECCANIZZAZIONE
MÉCANISATION
MECANIZACIÓN
MECHANISIERUNG



It is possible to open holes for auxiliary elements such as spotlights, air conditioning diffusers, fire systems, music systems. We can manufacture custom-made meshes, according to the needs of every project.

Possibile eseguire fori per elementi ausiliari come faretti, diffusori per il condizionamento dell'aria, impianti antincendio, impianti musicali. Siamo in grado di realizzare maglie su misura, secondo le esigenze di ogni progetto.

Il est possible d'ouvrir des trous pour des éléments auxiliaires tels que des projecteurs, des diffuseurs de climatisation, des systèmes d'incendie, des systèmes de musique. Nous pouvons fabriquer des mailles personnalisées selon les besoins de chaque projet.

Es posible la apertura de agujeros para elementos auxiliares tales como focos, difusores de aire acondicionado, sistemas contra incendio, sistemas de música. Podemos fabricar las mallas a medida, según las necesidades que cada obra requiera.

Es ist möglich, Löcher für Hilfselemente wie Strahler, Klima-, Brandschutz- oder Musikanlagen zu öffnen. Wir können kundenspezifische Maschen herstellen, je nach den Anforderungen jedes Projekts.

STUDIES

STUDI
ÉTUDES
ESTUDIOS
STUDIEN



We can carry out studies for all kind of ceiling projects, combining materials, types of meshes, dimensions and/or edges, which will surely satisfy your needs.

Possiamo effettuare studi ad hoc per ogni tipo di controsoffitto, combinando materiali, tipi di maglia, dimensioni e/o lati, che soddisferanno certamente ogni tua esigenza.

Nous pouvons réaliser des études sur vos projets éventuels de faux-plafond, combinant matériaux, types de maillage, mesures et / ou arêtes, qui satisferont sûrement vos besoins.

Podemos realizar estudios a medida de su posible necesidad de techo, combinar materiales, tipos de malla, medidas, y/o cantos, que con toda seguridad satisfarán sus inquietudes.

Wir können Studien für alle Arten von Zwischendecken durchführen, Materialien, Maschen, Maße zusammenstellen, die sicherlich alle Ihre Bedürfnisse befriedigen werden.



REFERENCE PROJECTS

REFERENZE
TRAVAUX DE RÉFÉRENCE
REFERENCIA OBRAS
REFERENZEN









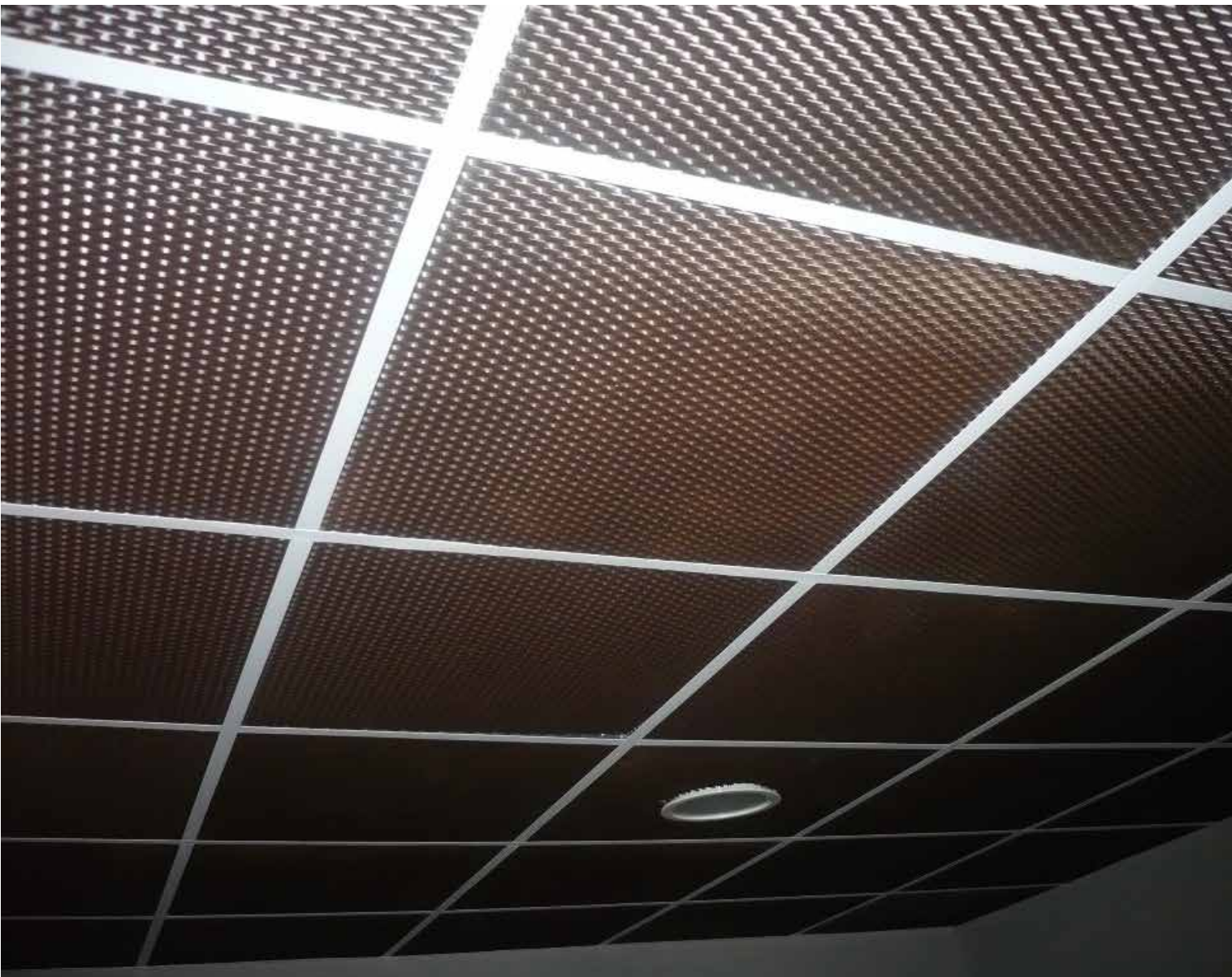



Fratelli Mariani S.p.A.



Via Cadorna, 34 - Cormano (MI) - Italy
Ph. +39 02 610344.1 - F. +39 02 61034499
info@fratellimariani.it

www.fratellimariani.it